

TRUBLUE SPEED AUTO BELAY

Operator Manual

Model: TBSD150-20



NOTE TO INSTALLERS

Always Read Instructions Before Use

Leave this Operator Manual attached to the auto belay. The Operator Manual contains information relating to the safe use of the TRUBLUE Speed Auto Belay and includes all product registration and warranty information. This document may only be removed by the end user. Ensure that this Operator Manual is readily available to operators at all times

Head Rush Technologies TRUBLUE Speed Operator Manual
P/N 11764-04

Head Rush Technologies products are covered by a number of patents, including U.S. Patents 8,490,751; 8,851,235; 9,016,435; 8,851,235 and D654,412 & corresponding patents/applications in the USA and in other countries worldwide.





TRUBLUE™
AUTO BELAY

RETRACTABLE LIFELINE WITH
AUTOMATIC DESCENT CONTROL

SPEED

head rush



IMPORTANT SAFETY NOTICE

Speed Climbing Is a Dangerous Activity

Read Before Installation & Operation

The practice of Speed climbing differs from other forms of rock climbing in that a) Climbers can gain height very quickly, and b) Climbers are focused on speed and sometimes don't pay enough attention to the safety systems provided by an operator.

Because of this fundamental difference, Speed climbers MUST be supervised at all times to ensure that the lanyard/rope always keeps up with the pace of the climber. In addition, operators MUST have a communication system in place to alert a climber if a webbing fails to retract or retracts slower than the climber ascends.

If a climber significantly exceeds the pace of his/her rope or lanyard, an unprotected fall from height can occur. **A FALL FROM HEIGHT MAY RESULT IN SERIOUS INJURY OR DEATH.**

Any device that fails to retract or keep pace with the climber must be removed immediately from service and diagnosed by the operator. If items external to the device (see below for examples) are responsible for retraction problems, these must be corrected before placing the TRUBLUE Speed device back into service. If items external to the device have been removed, and retraction problems persist, immediately send the device to your nearest authorized Head Rush Technologies service center.

Examples of external items that could prevent or affect retraction of a TRUBLUE Speed device:

- Foreign bodies becoming lodged in the nozzle.
- Route marking tape interfering with the webbing and/or becoming lodged in the nozzle.
- Protruding handholds, climbing wall features or climbing equipment interfering with lanyard retraction.

TABLE OF CONTENTS

1.0	SAFETY INFORMATION	6
1.1	Health and Safety	6
1.2	Symbols Used in this Manual	7
2.0	WARRANTY CONDITIONS	8
2.1	Customer Responsibility	8
3.0	CERTIFICATION	10
3.1	Standards	10
4.0	DESCRIPTION	11
5.0	SPECIFICATIONS	12
6.0	AUTO BELAY PARTS	13
6.1	Label	13
6.2	Location of Labels	14
6.3	Icon Descriptions	15
7.0	UNPACKING	17
7.1	Precautions	17
7.2	Receipt of the Auto Belay	17
7.3	Unpacking the Auto Belay	17
7.4	Storage	18
8.0	INSTALLATION	19
8.1	Precautions	19
8.2	Standards	19
8.2.1	<i>Anchor Points</i>	20
8.2.2	<i>Harness</i>	20
8.2.3	<i>Secondary Connectors</i>	20
8.2.4	<i>Selecting a Location</i>	21
8.2.5	<i>Outdoor Installations</i>	21
8.3	Mounting	22
8.3.1	<i>Mounting Points</i>	22
8.3.2	<i>Orientation</i>	23
9.0	OPERATION	24
9.1	Operator Training	25
9.2	User Instruction	25
9.3	Climbing Harness	27
9.4	Carabiner Use	27
9.4.1	<i>Operation</i>	27
9.4.2	<i>Secondary Connections</i>	28

10.0 INSPECTION & MAINTENANCE	29
10.1 Annual Recertification	29
10.2 Scheduled Maintenance	29
10.2.3 Safety Precautions	30
10.3 Daily Inspection	30
10.4 Weekly Inspection	30
10.4.1 Inspection Procedure	31
10.4.2 Webbing Wear	32
10.5 Six Month Inspection	35
10.5.1 Inspection Procedure	35
10.5.2 Webbing Inspection	35
10.6 Nozzle Replacement	36
10.7 Webbing Line Replacement	38
10.7.1 Safety Precautions	38
10.7.2 Webbing Line Replacement Procedure	38
10.8 Replacement Parts	40
10.9 Troubleshooting	41
10.10 Transportation	41
11.0 MANUFACTURER'S DETAILS	42

1.0 SAFETY INFORMATION

Failure by the operator to heed any and all instructions, warnings and cautions for the correct installation, operation, care and maintenance of the TRUBLUE Speed Auto Belay may result in death and/or serious injury.

TRUBLUE Speed Auto Belay Model TBSD150-20 12.5 meter and 16 meter and associated equipment are designed and specified for use in the recreational climbing industry as a controlled descent device. Use of the TRUBLUE Speed Auto Belay for any purposes other than that intended by the manufacturer is not permitted. Owners and operators of the TRUBLUE Speed Auto Belay are responsible for the safety and supervision of any person using the TRUBLUE Speed Auto Belay and are required to undergo training in the correct installation and operation of the device prior to any use. These instructions must be made readily available to the operator at all times. Prior to installation and use, all owners and operators must have read and shown to have understood all instructions, labels, markings, and safety information pertaining to the installation, operation, care, and maintenance of the TRUBLUE Speed Auto Belay system, its component parts, and all associated hardware. Failure to do so can result in death, serious injury and equipment damage.

1.1 Health and Safety

Owners and operators must abide by all Standards, International, Federal, State and Provincial laws, and any specific health and safety regulations pertaining to the installation and use of this product.

1.2 Symbols Used in this Manual

The following safety symbols are used throughout this manual to highlight potential dangers. One or more precautions may be associated with practices and procedures described within this manual. Failure to adhere to any precautions highlighted can result in death, serious injury, or equipment damage.

Ensure that you read and understand all safety procedures related to the working environment and the task you are performing.



DANGER

Indicates a hazardous situation exists that, if not avoided, will result in serious injury or death.



WARNING

Indicates a potentially hazardous situation that, if not avoided, could result in serious injury or death.



CAUTION

Indicates a potentially hazardous situation that, if not avoided, may result in injury or equipment damage.



NOTE

Indicates an action that must be taken to ensure personal safety and prevent damage to property or equipment.



CARE FOR THE ENVIRONMENT

Take care to minimize impact on the environment when carrying out this procedure.

2.0 WARRANTY CONDITIONS

The TRUBLUE Speed Auto Belay Device is warranted against factory defects in materials and workmanship (excluding specific Field Replaceable Wear Parts - see "Replacement Parts" section below) for a period of two (2) years from date of purchase. This warranty applies only to the original purchaser, and is contingent upon the owner/operator maintaining and using the device in accordance with TRUBLUE Speed Auto Belay instructions, including the requirement to continue to maintain annual re-certification as described in this Operator Manual. This Warranty is in lieu of all other warranties, express or implied.

The sole remedy for breach of this warranty, or for any claim in negligence or strict liability in tort, is the repair or replacement of any defective parts by Head Rush Technologies (Manufacturer). Upon notice in writing, Head Rush Technologies will promptly repair or replace all defective items. Head Rush Technologies reserves the right to have any defective equipment returned to its facility, transportation pre-paid, for inspection before making a repair or replacement.

This Warranty is null and void if parts other than genuine parts are used, or if any modifications or services have been performed on the device by anyone other than an authorized Head Rush Technologies servicing agent. This warranty does not cover any damages resulting from abuse to the device, damage in transit, or any other damage beyond the control of Manufacturer. Head Rush Technologies makes no warranties in respect to trade accessories or component parts which are not made by Head Rush Technologies. Head Rush Technologies expressly excludes from this Warranty the replacement of specific Field Replaceable Wear Parts (see "Replacement Parts" below) which include the nozzle, the webbing (line) kit, carabiners and/or any anchors supplied with the product.

No person, agent or Distributor is authorized to give any warranty, other than the one herein expressed, on behalf of Head Rush Technologies, or to assume for it any liability pertaining to such products. Head Rush Technologies expressly disclaims any implied guarantee of merchantability, or claim as to whether the device is suited for a particular purpose. Purchaser agrees that Head Rush Technologies shall not be held liable to Purchaser/Operator for damages of any kind, including but not limited to, lost or projected profits, equipment down time, or any losses considered to be caused by non-operation or servicing/re-certification down time of the equipment.

2.1 Customer Responsibility

The following items are considered to be the responsibility of the Customer and are therefore non-reimbursable under the terms of the warranty.

- Product installation.
- Normal maintenance, including daily, weekly and bi-annual inspections.

-
- Normal replacement of service items.
 - Replacements required because of abuse, misuse or improper operational habits of the operator.
 - Field replaceable wear parts.
 - Normal deterioration due to use and exposure.
 - The installer and operator must fully understand these instructions. Any questions must be submitted in writing to Head Rush Technologies.

Adherence to the Operator Manual, manufacturer's instructions, and advice given by authorized Head Rush service technicians is the responsibility of the buyer, installer, and operator.

3.0 CERTIFICATION

3.1 Standards



NOTE

If the TRUBLUE Speed Auto Belay is resold outside of the country of destination, the reseller must provide instructions for use, service, maintenance and repair in the language of the country of use.

The TRUBLUE Speed Auto Belay can be used as a climbing/descent system device only in combination with other components (harness, mounting hardware, etc.). It shall not be deemed suitable for use until it is ensured that the entire system complies with the requirements of appropriate regional, state, and federal directives/standards.

The TRUBLUE Speed Auto Belay conforms to Regulation (EU) 2016/425 and complies with the following prevailing Safety regulations:

- **AS/NZS 1891:** Industrial fall-arrest systems and devices – Part 3: Fall arrest devices
- **CSA Z259.2.3-99:** Descent Control Devices
- **EN 341: 2011 Class 1A:** Personal protection equipment against falls from a height – Descender devices
- **ANSI/ASSE Z359.4:** Safety Requirements for Assisted-Rescue and Self-Rescue Systems, Subsystems and Components.
- **EN 360:2002:** Personal protective equipment against falls from a height - Retractable type fall arresters
 - **Section 4.5:** maximum force <6kN for 136kg capacity

EU Declaration of Conformity:

EU Declaration of Conformity can be downloaded at this website address:

<https://headrushtech.com/resources/declarations-of-conformity.html>

Body controlling the manufacture of this PPE:

TÜV SÜD Product Service GmbH
Ridlerstraße 65
80339 München, Germany

Notified body performing the CE type exam:

TÜV SÜD Product Service GmbH
Ridlerstraße 65
80339 München, Germany

4.0 DESCRIPTION

The TRUBLUE Speed Auto Belay is a controlled descent device designed specifically for use in the climbing industry. The TRUBLUE offers a maximum descent height of 12.5 m (41 ft) or 16 m (52.5 ft) based on webbing length selected for your device. TRUBLUE Speed Auto Belays are suitable for climber weights ranging from 10 - 136 kg (22 - 300 lbs).

The design of the TRUBLUE permits simple installation and removal and incorporates an advanced self-regulating brake system and automatic line retraction. The patented braking mechanism offers climbers a smooth descent with a minimal variation in descent rate of both children and adults. There are no wearing parts in the brake mechanism, ensuring that reliability remains high while maintenance and operating costs are kept to a minimum.

To protect the longevity of the TRUBLUE, installation, care and use of the TRUBLUE Speed Auto Belay must be carried out in accordance with the instructions in this manual. The theoretical lifespan of the TRUBLUE Speed Auto Belay is unlimited with proper care and performing the required annual service maintenance. For planning purposes, we recommend a planned lifespan of 15 years.

5.0 SPECIFICATIONS

MODELS	TRUBLUE Speed: TBSD150-20		
CERTIFICATION	IN ACCORDANCE WITH EN 341:2011-1A AND EN 360:2002		
DIMENSIONS	380 x 320 x 216 mm (15 x 12.6 x 8.5 in)		
NET WEIGHT	19.75 kg (44 lbs)		
MATERIALS	CASING	Aluminum Alloy	
	INTERNAL PARTS	Zinc plated steel	
	NOZZLE	Modified Acetal plastic	
	NOZZLE INSERT	304 Stainless Steel	
	LINE	12.5 m: Polyamide/UHMWPE 16 m: UHMWPE/Polyamide	
	MODELS	MINIMUM	MAXIMUM
MOUNTING HEIGHT (NOZZLE TO GROUND)	TBSD150-20 12.5M (black webbing handle)	7.5m (24.6 ft)	12.5m (41.0 ft)
	TBSD150-20 16M (blue webbing handle)	12.0m (39.4 ft)	16.0m (52.5 ft)
CLIMBER WEIGHT	ALL MODELS	10 kg (22 lbs)	136 kg (300 lbs)
OPERATING TEMPERATURE	ALL MODELS	-4° C (25° F)	60° C (140° F)
	ALL MODELS (DRY)	-10° C (14° F)	60° C (140° F)
STORAGE TEMPERATURE	ALL MODELS	-20° C (-4° F)	60° C (140° F)
DESCENT SPEED	ALL MODELS	-----	2.0 m/s (6.5 ft/s)



METRIC UNITS ARE THE CONTROLLING UNITS OF MEASURE IN THIS MANUAL. IMPERIAL UNITS ARE PROVIDED AS A COURTESY AND HAVE BEEN ROUNDED. IF THE OWNER/OPERATOR/INSTALLER MUST MAKE ANY UNIT CONVERSIONS, THE METRIC UNITS SHOULD BE REFERENCED.

6.0 AUTO BELAY PARTS

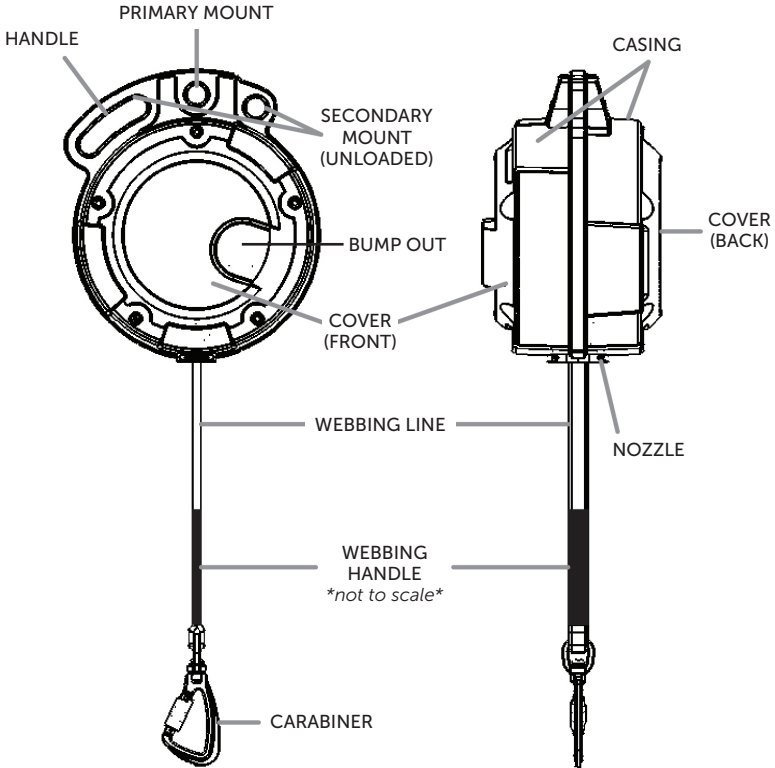

6.1 Label

TBSD150-20 SN#####

Model number

Unit serial number

CE0123

Notified body for CE type examination

IN ACCORDANCE WITH EN 341:2011-1A AND EN 360:2002

EN standard and device classification

6.2 Location of Labels

INFORMATION LABEL

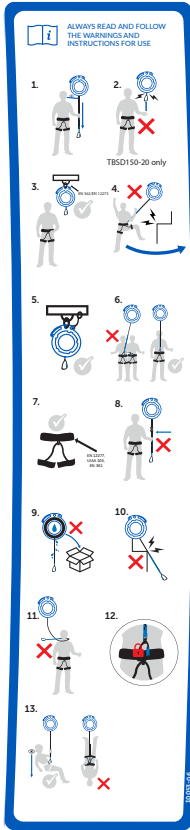

SERIAL NUMBER LABEL

TBSD150-20 SN#####

SPECIFICATION LABEL

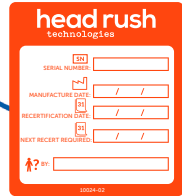
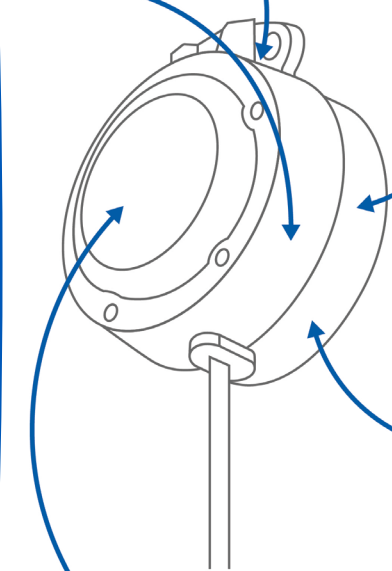
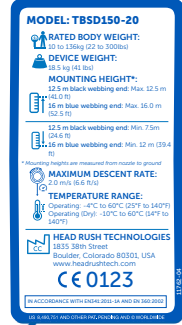

CERTIFICATION LABEL











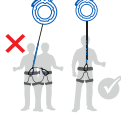

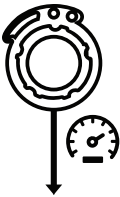
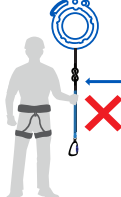

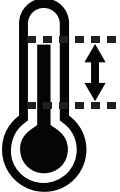
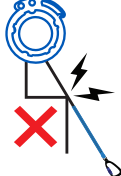

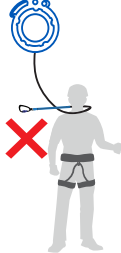

COVER LABEL

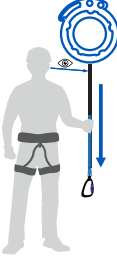
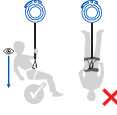
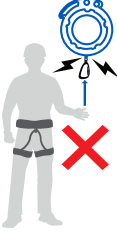

WEBBING DATE OF MANUFACTURE LABEL (Attached to Webbing)

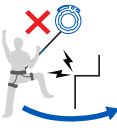
6.3 Icon Descriptions

	<p>Device Weight</p>		<p>Only one user at a time</p>
	<p>Body Weight</p>		<p>Harness standards</p>
	<p>Descent Rate</p>		<p>Do not alter the line. Do not clamp, knot or tie on additional line</p>
	<p>Country of Manufacture</p>		<p>Do not store the line inside the device wet</p>
	<p>Temperature Range</p>		<p>Never install the device where the line passes over sharp edges, high friction areas</p>
	<p>Minimum Height</p>		<p>Never permit line to wrap around or become entangled with neck, arms, or legs</p>

	<p>Maximum Height</p>		<p>Connect the carabiner to the designated belay loop of your harness, making sure the gate is locked</p>
	<p>Inspect the Webbing</p>		<p>Check descent path is clear, Always land with slightly bent knees to absorb landing</p>
	<p>Do not let TBSD150-20 (The TRUBLUE Speed only) retract uncontrolled</p>		<p>Serial number</p>
	<p>Minimum connector strength for installation</p>		<p>Manufacture Date</p>
	<p>Avoid swing falls into objects</p>		<p>Date</p>
	<p>Primary connector tight, secondary back-up connector loose</p>		<p>Technician</p>

7.0 UNPACKING

7.1 Precautions



LEAVE THIS USER MANUAL ATTACHED TO THE AUTO BELAY UNTIL INSTALLATION IS COMPLETE

The Operator Manual contains information relating to the safe use of the TRUBLUE Speed Auto Belay and includes all product registration and warranty information. The Operator Manual document may only be removed by the end user. Ensure this manual is readily available to Auto Belay users at all times.



DO NOT DISPOSE OF PACKAGING

The cardboard box and internal packaging are required for the return of the Auto Belay for the annual Certification inspection. Please keep packaging in a safe place until required.

7.2 Receipt of the Auto Belay

The TRUBLUE Speed Auto Belay is packaged in a recycled cardboard box and contains:

- 1 x TRUBLUE Speed Auto Belay Model TBSD150-20
- 1 x 12.5 m (41 ft) or 1 x 16 m (52.5 ft) Webbing Lower Line
- 1 x Carabiner or EN 362 connector attached to the Webbing Lower Line
- 1 x Operator Manual

The Auto Belay is shipped with the line and carabiner attached and does not require any further assembly.

7.3 Unpacking the Auto Belay

To unpack the Auto Belay:

1. Upon receipt of Auto Belay, inspect for signs of shipping damage or contamination. If Auto Belay shows any signs of damage or mishandling contact your Head Rush Technologies distributor.
2. Check that all labels affixed to Auto Belay are present and legible.



Do not use the Auto Belay after date shown here.

3. Check the Certification Label for the 'Next Recertification Required' date. If the date shown has passed or the label is missing or illegible, the Auto Belay must not be put into service.
4. Register your Auto Belay online at headrushtech.com/register.



PRODUCT REGISTRATION MUST BE COMPLETED

Product Registration is critical for receiving product notifications, re-certification notices, and up-to-date information for the safe use of the TRUBLUE Speed Auto Belay. Registration is fast and easy and can be done online at www.headrushtech.com/registration.

5. Read the Operator Manual and familiarize yourself with all aspects of installation, operation, care and maintenance.

7.4 Storage

If the Auto Belay is to be left unused for longer than two weeks, ensure the unit is clean and dry and line is fully retracted into the unit.

When returning the Auto Belay to duty after an extended period of inactivity, always carry out a full inspection and operational check.



DO NOT STORE IN WET CONDITION

After exposure to water or damp conditions thoroughly clean and dry the Auto Belay. Ensure Auto Belay is not left with wet webbing line retracted inside the casing. If the webbing is wet and the device is to be stored, remove the nozzle and pull all the webbing out until the shackle is exposed. Insert a pin through the line to prevent retraction, and allow the webbing to dry naturally away from open fire or heat source.

Always store in a clean and dry environment.

8.0 INSTALLATION

8.1 Precautions



ALWAYS USE DESIGNATED MOUNTING POINTS

Never install the Auto Belay using any part of the device apart from the designated mounting points. Incorrect mounting can result in serious injury or death.



ALWAYS USE THE CORRECT MOUNTING HEIGHT

Failure to install the device at the correct mounting height could result in damage to the device or loss in device performance.



MOUNTING

Always mount the TRUBLUE Speed Auto Belay unit so that the front cover with the bump out is facing away from the wall. See Section on Mounting (pg 22).



HARD IMPACTS MAY RESULT IN STRUCTURAL DAMAGE

Dropping of, or hard impacts to, the Auto Belay can result in serious damage to mounting points and internal parts and may compromise safety of operation. If the Auto Belay is subject to a hard impact, remove it from duty and return to a service agent for inspection.



HEAVY ITEM - 20 KG (44.1 LBS)

Take care when lifting the Auto Belay. Take care not to drop the device as this may result in serious injury or equipment damage.



ALWAYS MOUNT VERTICALLY

Always mount the Auto Belay vertically with the nozzle pointing downwards and the line exiting the bottom of the device. Failure to do so will result in incorrect operation and compromise User safety.



HARMFUL CONTACT

Do not allow solvents, acids, sharp edges etc. to get into contact with the device, especially the webbing. If in contact, the Auto Belay must be inspected.

8.2 Standards

Prior to installation, all Operators must be familiar with the requirements of all relevant Standards for anchor points, hardware and equipment used with the TRUBLUE Speed Auto Belay.

8.2.1 ANCHOR POINTS

All anchor points and connectors used with a TRUBLUE Speed Auto Belay must conform to any federal or state requirements for such devices.

Head Rush Technologies requires anchor points to have a minimum load capacity of 10 kN (2200 lbs) in expected directions of application. Other national and international standards for anchor points may apply and require higher load capacity. Consult with the authority having jurisdiction for your required load capacity.

The location and anchor points for the TRUBLUE Speed Auto Belay should comply with the following:

- Anchor points are not to be used by additional devices or as attachments for hardware not associated with the Auto Belay installation.
- Anchor points should be of a suitable size to correctly install any mounting hardware.

8.2.2 HARNESS

All harnesses used in conjunction with the TRUBLUE Speed Auto Belay must be of the correct size and fit, be in serviceable condition, and comply with one of the following standards:

- EN 361 - Personal protective equipment for prevention of falls from a height – Full body harness.
- EN 813 - Personal protective equipment for prevention of falls from a height – Sit harness.
- EN 12277 - Type A. Full Body Harness.
- EN 12277 - Type B. Small Full Body Harness.
- EN 12277 - Type C Sit Harness.

8.2.3 SECONDARY CONNECTORS

All secondary connectors and hardware used in the installation of the TRUBLUE Speed Auto Belay must conform to the requirements of:

- EN 362 - Types of connectors for personal protection.
- EN 12275 - Types of connectors for mountaineering.

All connectors, hooks, D-rings and shackles used to mount the TRUBLUE Speed Auto Belay must be of compatible size, shape and strength for the mounting point to which they are attached.

8.2.4 SELECTING A LOCATION

The TRUBLUE Speed Auto Belay is to be mounted at the top of the climbing route with the nozzle and webbing line pointed down.

When selecting a location to mount the Auto Belay, always check:

- The Auto Belay will hang vertically over the climbing route with the nozzle pointing down.
- All paths that can be used by the climber when connected to the Auto Belay are free of sharp edges and high-friction surfaces that may damage the webbing line.
- Ensure that the descent path and landing area are free of other climbers, pedestrians or obstacles that may cause entanglement or restrict the climber's ascent or descent.
- The Auto Belay is free to pivot in all directions and should not bind the mountings or be able to impact upon the surrounding structure.

8.2.5 OUTDOOR INSTALLATIONS

The TRUBLUE Speed Auto Belay may be installed outdoors.

It is recommended that in wet or high-variable temperature environments, the Auto Belay is protected from the direct ingress of water or foreign objects.



NOTE

Prolonged exposure to the elements will increase the risk of internal corrosion and degradation of the webbing line, resulting in increased operation and servicing costs. Increased inspections are required in these types of environments.

8.3 Mounting

With a suitable location for the Auto Belay selected, it can be mounted only using the methods and hardware described in this manual. When mounting the Auto Belay be aware of the following precautions:

- Mount the TRUBLUE Speed with the bump out on the front side cover facing AWAY from the climbing wall.

Front Side Cover with Bump Out
face away from climbing wall

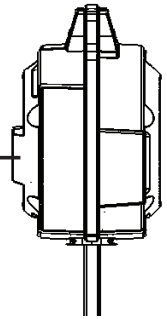

MOUNTING HEIGHT

When mounting the device, the distance between the nozzle and the ground must be no higher than 12.5 m (41 ft) for the 12.5 m webbing and between 12 m (39.5 ft) and 16 m (52.5 ft) for the 16 m webbing. Exceeding the allowable mounting height in either the 12.5 m or 16 m Speed devices will result in damage to the device. Mounting the 16 m Speed device lower than 12 m (nozzle to ground), will compromise reliability in retraction.

8.3.1 MOUNTING POINTS



USE ONLY THE DESIGNATED MOUNTING POINTS

Use only the correct mounting points. Use of incorrect points can result in equipment damage.

Ensure all mounting hardware is secure but free to pivot in mounting point.



ALWAYS MOUNT THE FRONT SIDE COVER WITH THE BUMP FACING OUT

The front side cover with the bump out should be mounted facing away from the climbing wall to avoid excess wear on the device or the wall.

The TRUBLUE Speed Auto Belay is manufactured with a single central pivot mounting point, an offset secondary mounting point and formed handle located at the top of the casing. These mounting points are located on the central plate and are located to ensure the unit hangs centrally and vertically with the line nozzle pointing down.

The Side Covers are a sacrificial protective cover designed to prevent damage to both the device and any adjacent surface. Should the covers become excessively worn, damaged, or aesthetically displeasing, they may be replaced by the user. Details of replacement parts may be found in the Replacement Parts section of this manual.

It is preferred to install the Auto Belay by using the central mounting point, as shown below, with a longer, non-loaded secondary mount utilizing the offset mount or handle mounting points. Ensure mounting hardware is secure and the unit is free to pivot in all directions.

Other mounting options are available. Contact Head Rush Technologies for more information.

8.3.2 ORIENTATION

Always mount the Auto Belay with the round covers parallel to the face of the climbing wall and the front cover with bump out facing away from the climbing wall. Mounting in this direction will allow the Auto Belay to swing laterally and minimize the wear on the webbing line, nozzle assembly and mounting points.

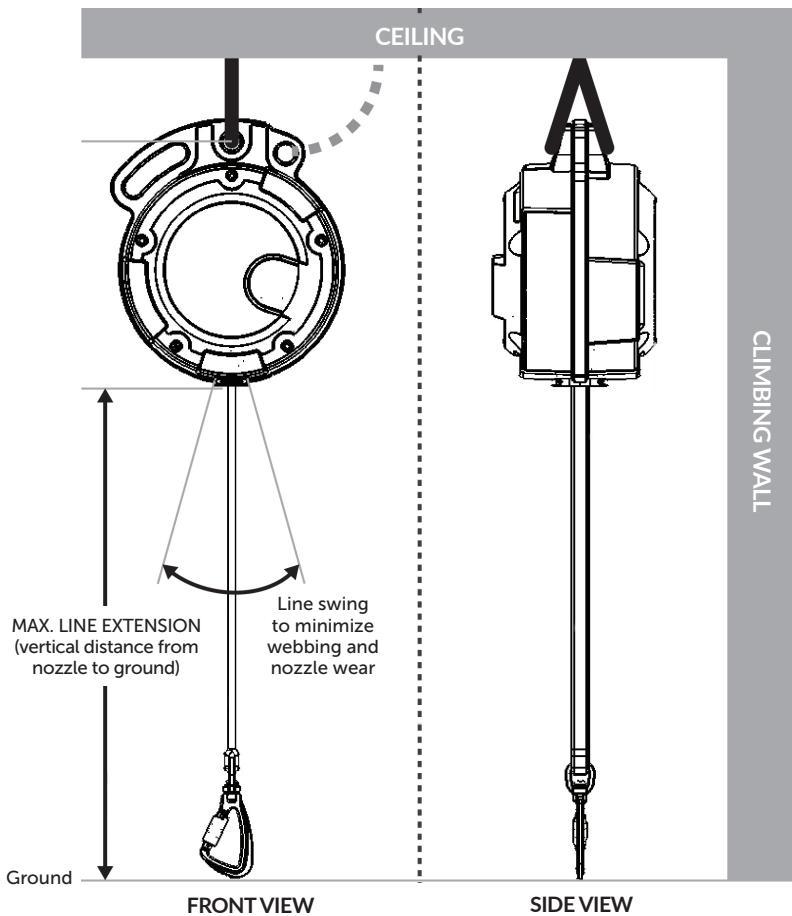

Mounting Dimensions

9.0 OPERATION

Owners and purchasers of the TRUBLUE Speed Auto Belay are responsible for the safety and supervision of any person using this equipment and are required by the manufacturer to read, understand and follow all instructions in this Operator Manual regarding the correct installation and operation of the Auto Belay prior to any use.



UNSAFE OPERATION

Remove Auto Belay from service immediately if there is any concern over its correct operation or user safety.

Do not return Auto Belay to service until it has been inspected and completed a recertification inspection and test by an approved Head Rush Technologies Service Agent.



DO NOT ALLOW UNCONTROLLED RELEASE OF THE WEBBING TO OCCUR.

Such a release can potentially injure other climbers in the area and damage the device. If such a release of webbing occurs, temporarily stop use immediately and conduct the following inspections based on inspection procedures outlined in this manual:

- Check that the webbing still retracts properly. Send the unit in for service if it does not retract.
- Inspect the entire webbing and carabiner for damage. Replace if damaged.
- Inspect the plastic portions of the nozzle for cracks. Replace if cracked.
- Place the device back in service if it passes all inspections.



EMERGENCY RESPONSE PLAN

Owners and operators must have devised an emergency rescue plan for any climber in distress at all sites operating TRUBLUE Speed Auto Belay Devices. Operators must inform Users of the Auto Belay of the procedure for rescuing a climber in distress prior to climbing.



STOP USE IMMEDIATELY IF ANY OF THE FOLLOWING OCCUR:

- Excessively fast webbing wear is noticed. Check unit mounting and replace webbing. Place the device back in service and check that fast webbing wear is resolved.
- The descent speed increases from its normal level. Wait for the device to cool down. Place the device back in service if descent speed has returned to its normal level.
- The device stops retracting webbing. Send the unit in for service.



EXTERNAL ITEMS PREVENTING RETRACTION

Any device that fails to retract or keep pace with the climber must be removed immediately from service and diagnosed by the operator. If items external to the device (see below for examples) are responsible for retraction problems, these must be corrected before placing the TRUBLUE Speed device back into service. If items external to the device have been removed, and retraction problems persist, immediately send the device to your nearest authorized Head Rush Technologies service center.

Examples of external items that could prevent or affect retraction of a TRUBLUE Speed device:

- Foreign bodies becoming lodged in the nozzle.
- Route marking tape interfering with the webbing and/or becoming lodged in the nozzle.
- Protruding handholds, climbing wall features or climbing equipment interfering with lanyard retraction.

9.1 Operator Training

All personnel involved in the operation of the Auto Belay must be trained and deemed competent in the following aspects of TRUBLUE Speed Auto Belay operation:

- Transportation and storage.
- Installation, use of attachment points and attachment methods and hardware.
- Inspection, cleaning, and scheduled servicing of the Auto Belay, its component parts and associated attachment hardware.

9.2 User Instruction



NEVER CLIMB WITHOUT BEING CORRECTLY ATTACHED

Ensure the carabiner is attached to the belay loop of the harness and the latch is fully closed and the gate engaged before starting to climb. A gate check must be performed after every connection.

Failure to do so can result in serious injury or death.



SPEED CLIMBING OPERATION

Speed climbers must be supervised at all times while using the TRUBLUE Speed Auto Belay. Operators must have a system in place to alert a climber if a webbing fails to retract or retracts slower than the climber. A slack line fall may result in serious injury or death.



WARNING

Climbing is considered a strenuous activity. If you have any physical or medical conditions that may affect your climbing ability consult a medical professional prior to participation.



POTENTIAL FOR PARTICIPANT ENTANGLEMENT

Potential for participant entanglement exists during descent. Ensure all loose items that may become tangled are tightened or removed before using the Auto Belay. A risk assessment should be completed at the installation site to determine the necessary PPE for climbers.

Prior to clipping in, all climbers must be instructed in the safe use of the Auto Belay. Operators are to ensure all climbers are familiar with the site rescue plan in the event the climber becomes distressed.

Prior to climbing the user must be aware of, and completely understand, the following precautions:

- Check Auto Belay operation by pulling out a short section and allowing it to retract.
 - If the Auto Belay stops retracting for any reason while attached, STOP CLIMBING. If there is no slack in the line, jump onto the webbing and the Auto Belay will descend. Notify the operator immediately.
 - If the Auto Belay line fails to retract, do not clip into the Auto Belay and request assistance.
- Check the climbing harness is correctly fitted and tightened.
- Check the carabiner from the Auto Belay line is connected to the designated loop on the climbing harness and the gate is properly closed.
- Ensure the carabiner latch gate is facing away from the climber.
- Never start descent from above the Auto Belay.
- Prior to descent, ensure descent path and landing area are free of people and obstructions.
- Avoid swinging while descending.
- Always descend feet first using feet to fend off obstacles and prepare for landing.
- After climbing, reattach the connector to the belay gate an appropriate connection point at the bottom of the wall.

9.3 Climbing Harness



USE AN APPROVED HARNESS

Always use a climbing harnesses complying with the standards specified in this manual. Ensure the harness is appropriate for use, in a serviceable condition and correctly fitted. Always follow the harness manufacturer's instructions for fit, care and use.

9.4 Carabiner Use

On some models, a triple locking self closing carabiner is supplied as an integral part of the descent line. The carabiner must be checked and be in serviceable condition before any use. Ensure the carabiner is only loaded along its vertical direction.



NOTE

If the integral carabiner is damaged or unserviceable, the complete webbing line must be replaced. Use only genuine TRUBLUE replacement parts.

9.4.1 OPERATION

Triple lock carabiners are opened by sliding the gate down, rotating the gate's collar and pushing the gate open towards the center of the carabiner.

- Attach the carabiner to the correct loop on the harness with the latch facing away from the user.
- Allow the latch to snap shut, ensuring the collar has rotating back and is locked. Ensure that no clothing, webbing or other objects are obstructing the gate or latch.
- Double check that the latch is secure.



Step 1 - Slide



Step 2 - Twist

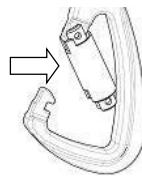

Step 3 - Depress

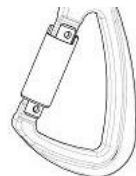

Step 4 - Release

Carabiner Operation

9.4.2 SECONDARY CONNECTIONS

Based on the site risk analysis, a secondary connector may be recommended to be used with an Auto Belay. Head Rush Technologies offers several options for secondary connectors, or continuous connection systems.

10.0 INSPECTION & MAINTENANCE

10.1 Annual Recertification



DO NOT OPERATE AFTER THE DATE SHOWN ON THE CERTIFICATION LABEL

Operation of a TRUBLUE Speed Auto Belay without a current Certification Label visible will be strictly forbidden. Severe bodily injury or death may occur.



SHIPPING

When shipping the TRUBLUE Speed Auto Belay for recertification or service, place it in the box with the bump out on the front cover facing up and the white foam facing up.

The TRUBLUE Speed Auto Belay requires an annual service and recertification inspection to be carried out by an authorized Head Rush Technologies service agent.

The Certification expiration date is shown on the Certification Label located on the side of the front casing. Dismount the Auto Belay and return to the Manufacturer at the address shown at the back of this Manual or to an Authorized Service Center prior to the expiration date.



Do not use the Auto Belay after date shown here.

10.2 Scheduled Maintenance

The following inspection and service actions must be carried out by the operator or operator-trained staff. All personnel performing these actions must be trained in the correct procedures and deemed competent to do so.



NO UNAUTHORIZED SERVICING

Do not attempt to carry out any maintenance, repair or service actions not detailed in the User Manual.

Any unauthorized maintenance, repair or modifications to the Auto Belay will compromise safety, render the unit not fit for use, and void the warranty provisions.



NOTE

Inspect in a clean environment. If Auto Belay has been removed from its operational location for service, ensure that the service area is clean and free from contaminants.

Ensure unit is securely placed on a sturdy work table and that side covers are not subject to damage.

10.2.1 SAFETY PRECAUTIONS



HEAVY OBJECT – 20 KG (44.1 LBS)

Ensure the Auto Belay device is secured during service to prevent accidental damage or injury from dropping.



CAUTION – SPRING LOADED PARTS

The webbing assembly is spring loaded and will rapidly return into the device if released. This may result in damage or injury.



MAGNETIC PARTS

The Auto Belay contains strong magnets. Always ensure working environment is free of loose ferrous materials. Ingress of metal objects may compromise belay operation.

10.3 Daily Inspection

The daily webbing inspection must include at least a visual inspection sufficient to evaluate the wear and integrity of the device's webbing. Please see "Webbing Wear" below for a detailed description of when a webbing should be taken out of service. The inspection may be performed from the ground if the webbing can be adequately inspected. Ensure that the line fully retracts and that consistent tension is felt throughout retraction.

10.4 Weekly Inspection

The TRUBLUE Speed Auto Belay must be inspected weekly for correct operation and overall condition. The weekly inspection may be carried out with the unit in place or removed to a sturdy work table.

10.4.1 INSPECTION PROCEDURE

Ensure adequate lighting and unrestricted access is available to permit a thorough inspection of all areas of the Auto Belay. This inspection should be completed either with the Auto Belay dismounted or by climbing to the location of the Auto Belay and anchoring in, so you may visually inspect the unit and the entire length of webbing.

1. Clean any dust, dirt or contamination off the casing and fittings with a clean cloth.



DO NOT USE SOLVENTS OR ABRASIVES

Clean with a cloth only. Do not use any cleaners, solvents or abrasives on any part of the Auto Belay or its associated equipment.

2. Visually inspect the casing, mounting holes and plastic covers for wear, impact damage, cracking, deformation and corrosion. Replace any damaged items or remove Auto Belay from service.
3. Check all safety labels are in place and in good condition.
4. Check date on Certification Label is current.
5. Inspect the condition of the carabiner, checking for:
 - Wear and damage.
 - Correct operation of the locking mechanism.
 - Smooth operation of the carabiner swivel.If the carabiner gate or swivel does not automatically lock or rotate, lubricate per the carabiner manufacturer's recommendations, which include a dry, wax-based or PTFE-based lubricant, until fully operational. If full functionality cannot be restored, replace the entire webbing assembly.
6. Slowly pull out the entire length of webbing from the unit. As webbing is withdrawn, inspect for:
 - Damage, cuts or abrasion to stitching.
 - Cutting, wear and abrasion to the surface of webbing.
 - Discoloration, fading or chalking of the surface.
 - Heat and friction damage such as hard or shiny areas.
 - Contamination from dirt or chemicals.
 - Twisting or knotting.Replace webbing if any signs of wear or damage are present.
7. Allow the webbing to slowly retract into the casing – checking the retraction action is strong and smooth.

8. Complete and file 'Weekly Inspection Log' documentation.
9. Return Auto Belay device to service.

10.4.2 WEBBING WEAR









INSPECT WEBBING DAILY

Webbing in your TRUBLUE must be evaluated on a daily basis. A detailed description of when a webbing should be taken out of service is included in the Wear Tables below. Webbing **MUST** be taken out of service by the time the webbing resembles the stage of wear designated in the Wear Tables. Continued use of webbing with wear at or beyond the designated stage of wear below may result in serious injury or death.

WEAR TABLES

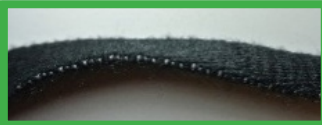
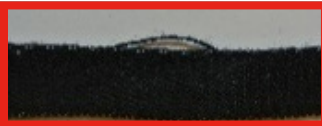
Webbing pictures outlined in **red** in the tables below show webbing that **MUST** be taken out of service and replaced immediately to continue using your TRUBLUE. The **green** outlined photos show webbing that can be kept in operation.

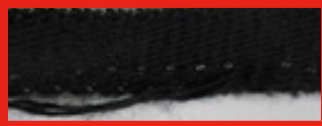

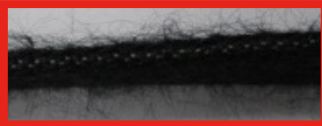



TRUBLUE 12.5 m

Degree of Wear	Edge Wear	Face Wear
NEW		
STAGE 1		
STAGE 2		
STAGE 3		
STAGE 4		

WEAR TABLES

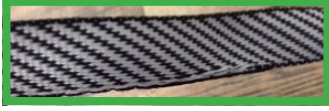
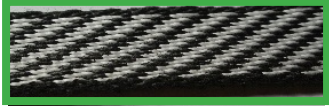
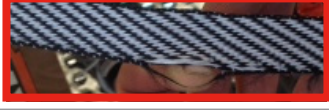
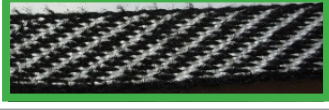
Webbing pictures outlined in **red** in the tables below show webbing that **MUST** be taken out of service and replaced immediately to continue using your TRUBLUE. The **green** outlined photos show webbing that can be kept in operation.

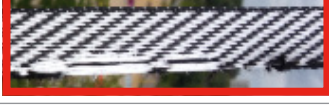
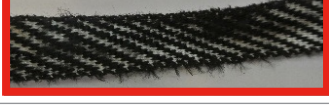
TRUBLUE 16 m

Degree of Wear	Edge Wear	Face Wear
NEW		
STAGE 1		
STAGE 2		
STAGE 3		
STAGE 4		
STAGE 5		

MOLDY WEBBING

Any webbing showing signs of mold should be taken out of service.

TROUBLESHOOTING WEBBING WEAR

Symptoms	Potential Causes	Potential Solutions
WEBBING FACE WEAR SIDE WEAR & LOOP FAILURE	Climbers are excessively swinging as they descend	Mark out auto belay boundaries so climbers do not pendulum greatly as they descend.
	Stainless steel nozzle insert is damaged	Inspect nozzle insert for burrs and other damage. If damage found, replace nozzle.
	TRUBLUE is mounted incorrectly	Ensure that the TRUBLUE is mounted according to Operator Manual, whether single or dual-point mounting. Make sure that the TRUBLUE is not angled. Always mount TRUBLUE vertically with nozzle pointed down and sides parallel to wall.
	Foreign objects, including dirt and/or dust have introduced damage to webbing assembly	Make sure to cover the TRUBLUE when not in use. Wipe the webbing with a dry cloth daily, after use.
	Normal use of TRUBLUE	Parts and webbing wear over time with normal operation, replace webbing as necessary.
WEBBING FACE WEAR SIDE WEAR LOOP FAILURE & HAND GRIP WEAR	Webbing is rubbing on the wall (overhang or corner of wall)	Move the TRUBLUE so the webbing does not rub on the wall/corner.
	Webbing is rubbing on a hold	Look for problem holds. Move the hold. Do not place large holds immediately below TRUBLUE.
	Foreign objects, including dirt and/or dust have introduced damage to webbing assembly	Make sure to cover the TRUBLUE when not in use. Wipe the webbing with a dry cloth daily, after use.
	Normal use of TRUBLUE	Parts and webbing wear over time with normal operation, replace webbing as necessary.
BAR TACK DAMAGED	Climbers are able to climb too close to TRUBLUE	Ensure that climbers cannot climb high enough to contact the bar tacks with the nozzle. Remove holds below TRUBLUE or mount the TRUBLUE higher.
UV FADED WEBBING	Sun is damaging webbing	Remove TRUBLUE at the end of day or cover unit and webbing after use.
HAND GRIP WEAR	Hand grip is rubbing against wall/holds	Look for problem holds. Move the hold.
	Normal use of TRUBLUE	Parts and webbing wear over time with normal operation, replace webbing as necessary.
WEBBING IS MOLDY/ DISCOLORED	Webbing is not being dried after being used in wet conditions	Whenever using the TRUBLUE in wet conditions, take the unit down at the end of the day, extend the webbing in a sanitary environment, and allow webbing to dry outside of the unit.

10.5 Six Month Inspection

The TRUBLUE Speed Auto Belay requires an in depth six (6) month inspection by the Operator to maintain its safe and efficient operation. For the six month inspections the unit must be dismantled and removed to a sturdy work table.

10.5.1 INSPECTION PROCEDURE

1. Dismount the Auto Belay (refer to Installation Instructions).
2. Clean Auto Belay using a clean cloth.
3. Carry out Steps 1 through 6 of the 'Weekly Inspection'.
4. Remove the nozzle – Refer to **"To remove the nozzle assembly"** section.
5. Inspect Nozzle Assembly for the following:
 - Excessive wear to slot, which could affect retraction of the webbing.
 - Splitting, cracking and deformation.
 - Correct fit in housing.

10.5.2 WEBBING INSPECTION

1. With Nozzle assembly removed, refer to "To remove the nozzle assembly," pull out the complete webbing line, including approx. 100 mm (4 in) of the drum lead.
 - Place a suitable pin through the loop in the drum lead, above the joining link to prevent it retracting back into the unit.
2. Inspect both the upper (drum) webbing and the webbing line by passing the webbing slowly through your hands under a good light. Inspect the webbing for:
 - Damage to stitching (cuts or abrasion).
 - Cuts to webbing, especially to edges.
 - Abrasion across the surface of the webbing, wear and fraying, especially to the edges and the webbing loops.
 - UV degradation – although difficult to detect, visual indications are discoloration, fading and chalking of the webbing surface.
 - Chemical attack, this can result in soft or weak fibers, color change or flaking of the surface.
 - Heat or friction damage, indicated by hard fibers or glazing of the surface.
 - Contamination from dirt, grit, sand or rust.
 - Twisting, knotting or permanent deformation of webbing.

Replace the webbing if any signs of damage or deterioration are present.

3. Inspect the webbing joining shackle. Ensuring that:

- The shackle pin is secure and straight – do not attempt to tighten or loosen.



NOTE

The shackle pin is secured with thread locking compound and any attempt to turn will compromise its security.

- The shackle is undamaged and in the correct orientation.
- The webbing around the link is not worn or damaged.

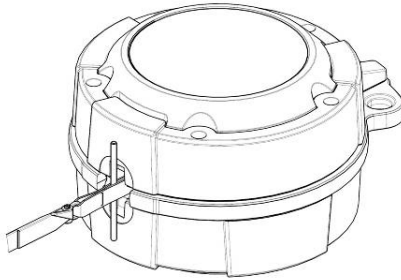

Webbing Retaining Pin

4. Remove the pin and allow the drum lead to slowly retract into the casing. Inspecting the webbing as it retracts and ensuring that the webbing line does not twist.
5. Refit the nozzle – Refer to **“To refit the nozzle assembly”** section.
6. Complete the “Six Month Inspection” documentation.
7. Return Auto Belay to service.

10.6 Nozzle Replacement

If the nozzle assembly shows signs of excessive wear that could impede retraction of the webbing, damage, or poor fit it must be replaced.



USE ONLY GENUINE TRUBLUE REPLACEMENT PARTS



ALWAYS REPLACE NOZZLE AS A PAIR

If nozzle requires replacement, always replace as a matched pair – do not mix worn and new nozzle pieces.

To remove the nozzle assembly:

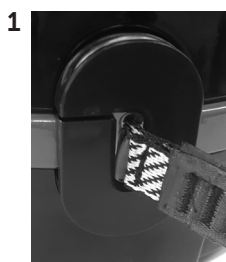

Assembled nozzle



Remove alignment pin

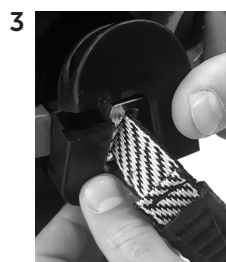

Lift and remove the two halves.

To refit the nozzle assembly:



Ensure webbing is free of twists when aligning nozzle insert

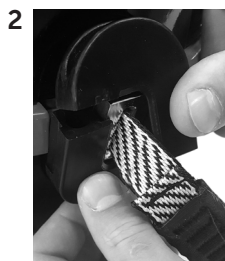

Join nozzle housing halves with nozzle insert

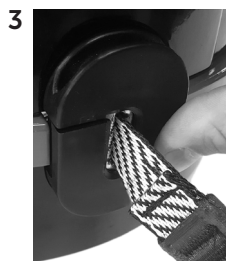

Press halves and nozzle insert into place



Insert alignment pin

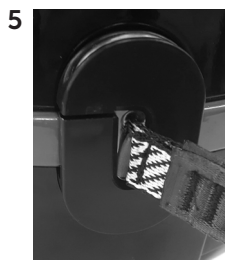

Press alignment pin into place

10.7 Webbing Line Replacement

If the lower webbing line shows signs of wear, damage or contamination then it will need to be replaced. The short webbing loop inside the device does not receive wear under normal operation and is not inspectable by the operator. Replace Line as follows:

10.7.1 SAFETY PRECAUTIONS



DO NOT ALLOW LINE OR DRUM LEAD TO RETRACT INTO HOUSING

With nozzle removed take care to not permit uncontrolled retraction of drum lead or webbing line into casing. Uncontrolled retraction will result in internal damage and require repair by the manufacturer.



USE ONLY GENUINE TRUBLUE REPLACEMENT PARTS

10.7.2 WEBBING LINE REPLACEMENT PROCEDURE

To replace the webbing line:

1. Remove the Auto Belay from service and place securely on the work bench.
2. Remove the nozzle – Refer to **“To remove the nozzle assembly”**.
3. While holding Auto Belay securely, pull out the webbing line until the end of the drum lead and the joining shackle are exposed.
4. Locate the loop in the drum lead, approx. 150 mm (6 in) past the link - Place a suitable pin through the loop in the drum lead to prevent it retracting back inside the casing.

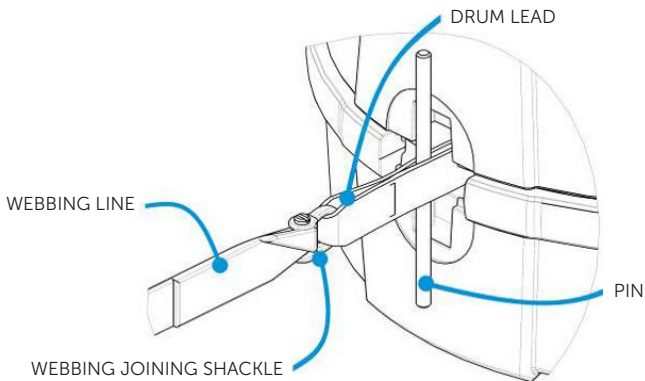

Webbing joining link parts

5. Unscrew the shackle pin.
6. Remove webbing line and complete shackle assembly from the drum lead.
7. Fit new shackle supplied with the line – Ensure the loop part of the shackle is fitted to the drum lead.



THREAD LOCKING COMPOUND

Ensure the factory applied thread locking compound is present on the shackle pin threads. Do not reuse the Shackle Pin.

8. Fit the new webbing line, passing the threaded shackle pin through the loop as shown on the next page.

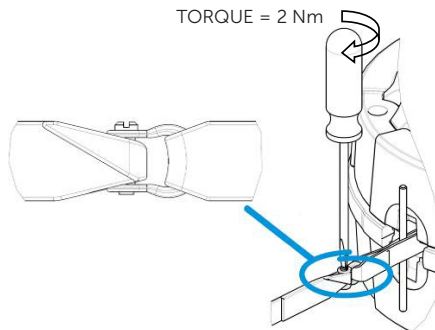

Correct shackle fit

9. Tighten the shackle pin to 2 Nm (18 lb-in), ensuring the threads are fully engaged and the end of the pin is flush with the joining shackle as shown.
10. Remove the holding pin and allow the new line to slowly retract until drum lead and joining link is inside casing. Ensure that the webbing line does not twist.



Once shackle pin is tightened, it must not be loosened or re-tightened. This will break the locking compound and the shackle pin may become loose. The shackle pin must be replaced if the retaining compound is compromised.



Ensure that the webbing line feeds squarely and without twists when retracting back into the auto belay.

Failure to do so may result in equipment failure, serious injury or death to participants.

11. Refit the nozzle – Refer to **“To refit the nozzle assembly”** section.
12. Slowly retract the webbing line into the casing, checking the action is smooth and adequate spring resistance is felt.
13. Once line is fully retracted, pull out line a short distance using reasonable force and allow it to retract. Repeat two to three times to ensure line is firmly wound onto the drum.
14. Return Auto Belay to service and check for correct operation.

10.8 Replacement Parts

Your TRUBLUE Speed Auto Belay is fitted with a number of user replaceable parts that may be refitted without the need to return the device to an authorized Head Rush Technologies Service Center. Always follow the Manufacturer’s instructions as detailed in this User Manual and any Part Replacement Guide supplied when undertaking replacement of a part.



NOTE

For optimal performance of your TRUBLUE Speed Auto Belay, only use genuine TRUBLUE parts and accessories.

To order replacement parts or accessories, contact your authorized Head Rush Technologies Distributor or go to <https://store.headrushtech.com>.

10.9 Troubleshooting

Refer to <http://headrushtech.com/troubleshooting> for troubleshooting instructions or contact your authorized Head Rush Technologies Distributor or Service Center.

10.10 Transportation



When shipping the TRUBLUE Speed Auto Belay for recertification or service, place it in the box with the bump out on the front cover facing up and the white foam facing up.

To ensure safe shipment of your auto belay, it should only be shipped in an authorized TRUBLUE Speed packaging (box and packing material). If you have misplaced your original packaging, purchase replacement packaging from an authorized Head Rush Technologies Distributor or Service Center, or online at <https://store.headrushtech.com>. When shipping the unit back to an authorized Head Rush Technologies Service Center, place it in the box with the front cover with bump facing UP and the white foam facing UP. You will be responsible for the cost of any damage and necessary repairs due to shipping your auto belay in unauthorized packaging.



CARE FOR THE ENVIRONMENT

Reuse the original packaging when shipping Auto Belay.

11.0 MANUFACTURER'S DETAILS

For Recertification or unscheduled service or repairs, return your TRUBLUE Speed Auto Belay to your nearest Head Rush Technologies Authorized Service Center or to the Manufacturer at the address shown below.

ADDRESS

Head Rush Technologies
1835 38th Street
Boulder, CO 80301
USA

CONTACT DETAILS

+1-720-565-6885
www.headrushtech.com
info@headrushtech.com

To find a Service Center outside the U.S., visit headrushtech.com/distributors/service-centers.

EU importers may apply their name and address on the device to comply with government regulations next to the specification label.



TRUBLUE™
AUTO BELAY

SPEED

RETRACTABLE LIFELINE WITH
AUTOMATIC DESCENT CONTROL

headrush

READ THE USER MANUAL CAREFULLY
BEFORE USING THIS DEVICE TO AVOID
INJURY OR DEATH. ALWAYS WEAR YOUR
SEATBELT AND SAFETY HARNESS.





REGISTER YOUR DEVICE

Get automatic updates on recertification and product information – visit [*headrushtech.com/register*](https://headrushtech.com/register)

ANNUAL RECERTIFICATION IS REQUIRED

Please keep the shipping box for your device. For instructions on annual recertification, visit [*headrushtech.com/recertification*](https://headrushtech.com/recertification)

+1-720-565-6885

www.headrushtech.com

info@headrushtech.com

March 2019